

## PAR30-5EYW5W

### Features

- \* Aluminum housing
- \* CE approved
- \* Eco-product
- \* Extended longer life
- \* High luminance
- \* Low power consumption
- \* RoHS compliant
- \* Well heat sink
- \* Wide viewing angle

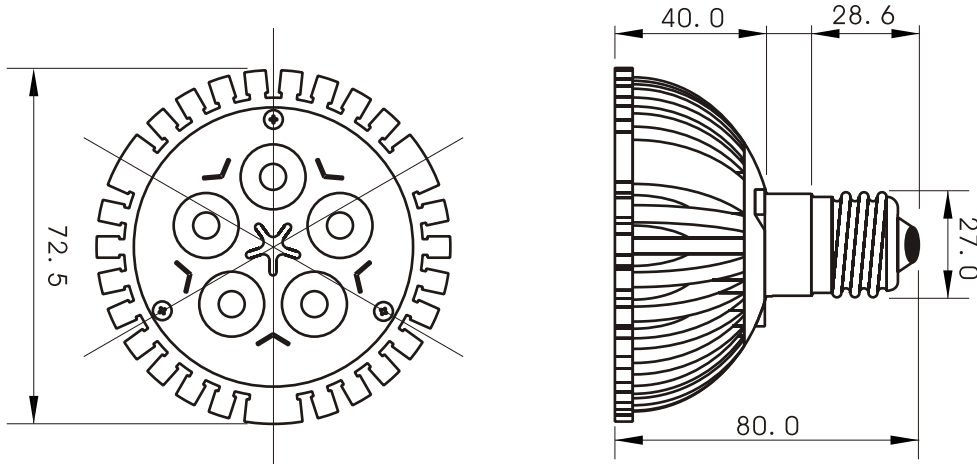

### Specifications

Base type	PAR30
Forward Current	350mA
Input voltage	AC 85-220V,50/60Hz
Light source	5x1W power LED
Color	Yellow
Luminous Intensity	220-250Lm
Operating temperature	-40-+70deg
Size	80x72.5mm
Viewing angle	60deg
Weight	182g

#### Important:

- \* Bulb electricity is compatible with the light socket voltage.
- \* The power is off while plug the light bulb into the socket.
- \* Suitable for dimmer switches or remote controls.
- \* Specified performance measured in 85-220V range.
- \* Do not look permanently to the light sources.

