

MR16-1FBE1W

Features

- * Aluminum housing
- * CE approved
- * Eco-product
- * Extended longer life
- * High luminance
- * Low power consumption
- * RoHS compliant
- * Well heat sink
- * Wide viewing angle

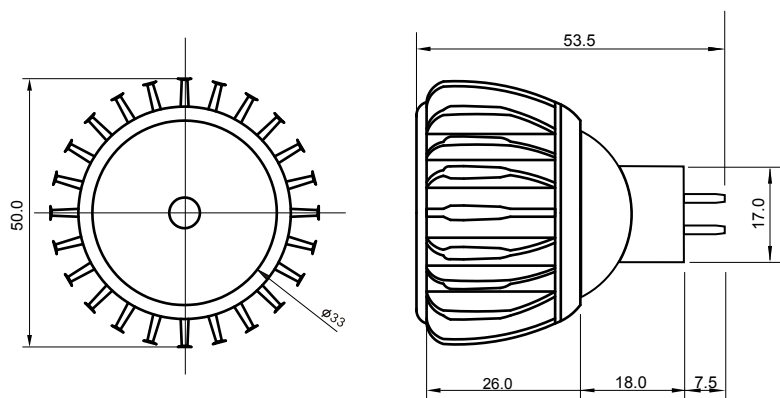

Specifications

Base type	MR16
Forward Current	300mA
Input voltage	AC /DC 12V
Light source	1x1W power LED
Color	Blue
Luminous Intensity	8-12Lm
Operating temperature	-40-+70deg
Size	50x54mm
Viewing angle	45deg
Weight	48g

Important:

- * Bulb electricity is compatible with the light socket voltage.
- * The power is off while plug the light bulb into the socket.
- * Suitable for dimmer switches or remote controls.
- * Specified performance measured in 85-220V range.
- * Do not look permanently to the light sources.



NOTES: 1. All dimensions are in millimeter (inches), tolerance is 0.25 unless otherwise noted.
2. Specifications are subject to change without notice.