

L100SPGC

Features

- * 10.0mm x 13.6mm round LED lamp
- * Low power requirement
- * I. C. Compatible
- * Easy assembly
- * RoHs compliant
- * Wide viewing angle
- * Bicolour version available

Part No.	Chip		Lens
	Ram Material	Emitted colour	
L100SPGC	GaN	Pure Green	Water Clear

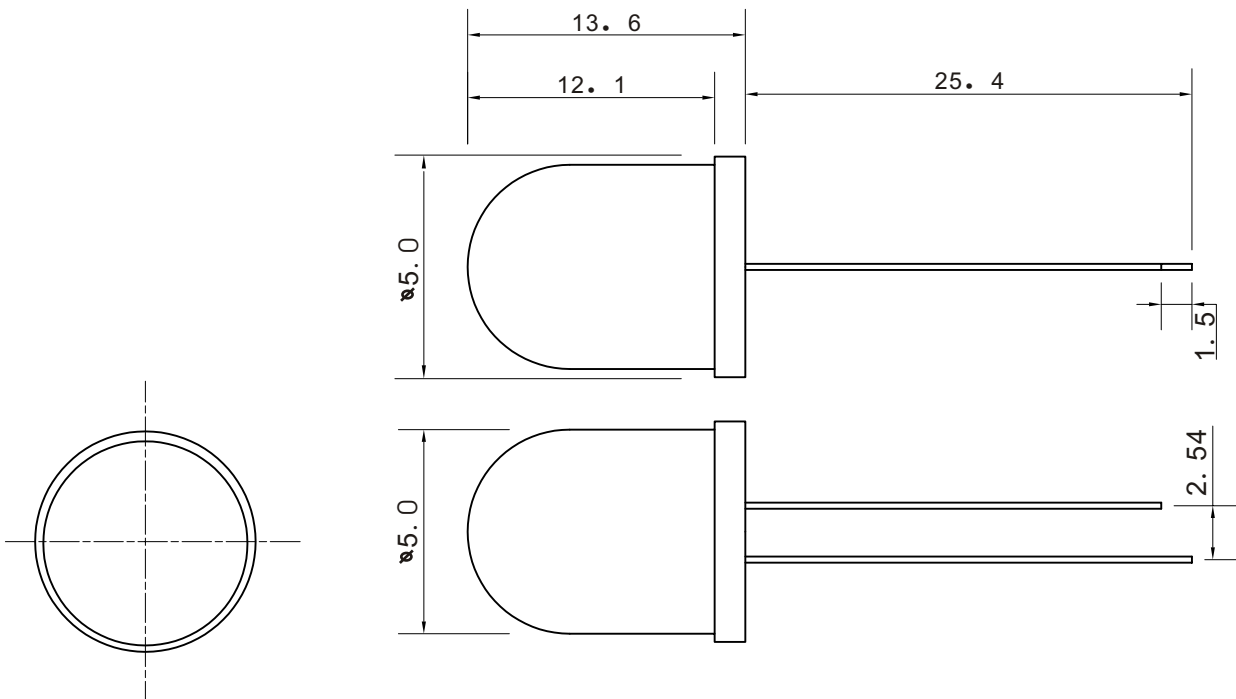

NOTES: 1. All dimensions are in millimeter (inches), tolerance is 0.25 unless otherwise noted.
2. Specifications are subject to change without notice.

Absolute Maximum Rating: (TA=25°C)

Parameter	Symbol	Maximum Rating	Unit
Peak Forward Current	IFp	100	mA
Forward Current	IF	20	mA
Reverse Voltage	VR	5	V
Power Dissipation	PD	70	mW
Operating Temperature	Topr	-40~+85	°C
Storage Temperature	Tstg	-40~+85	°C
Electrostatic Discharge	ESD	500	V
Soldering Temperature	260°C for seconds		

Lead soldering Temperature (4mm from body) : 260°C for seconds

Optical-Electrical Characteristic: (TA=25°C)

Parameter	Symbol	Condition	Min	Type	Max	Unit
Forward Current	VF	IF=20mA	3.0	-	3.6	V
Reverse Current	IR	VR=5V		-	5	uA
Dominant Wavelength	λ_d	IF=20mA			525	nm
Peak Wavelength	λ_p	IF=20mA	520	522	525	nm
Luminous Intensity	Iv	IF=20mA	12000	-	17000	mcd
Viewing Angle	2 θ 1/2	IF=20mA	-	35	-	Deg

Fig. 1

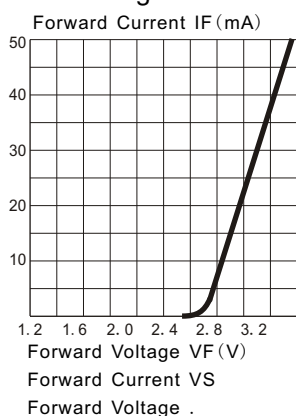

Fig. 2



Fig. 3



Fig. 4

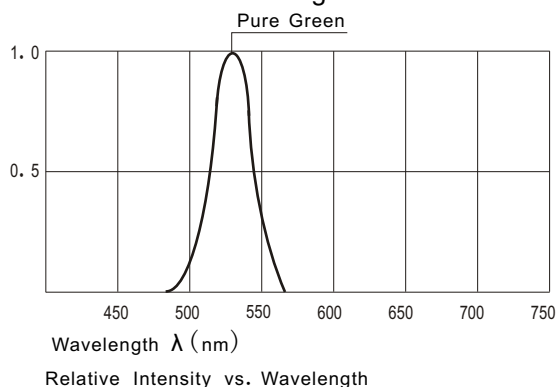

Fig. 5

