

## E27-1CWW1W

### Features

- \* Aluminum housing
- \* CE approved
- \* Eco-product
- \* Extended longer life
- \* High luminance
- \* Low power consumption
- \* RoHS compliant
- \* Well heat sink
- \* Wide viewing angle

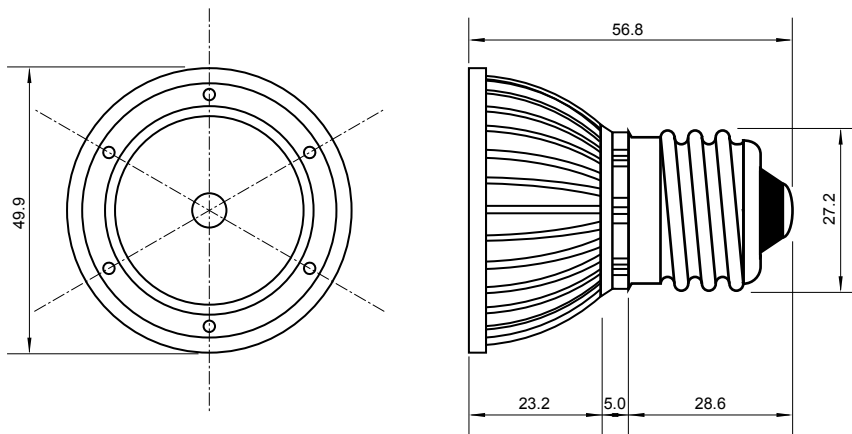

### Specifications

Base type	E27
Forward Current	300mA
Input voltage	AC 85-220V,50/60Hz
Light source	1x1W power LED
Color	Warm White(3000k-5000k)
Luminous Intensity	40-50Lm
Operating temperature	-40-+70deg
Size	50x60mm
Viewing angle	45deg
Weight	60g

#### Important:

- \* Bulb electricity is compatible with the light socket voltage.
- \* The power is off while plug the light bulb into the socket.
- \* Suitable for dimmer switches or remote controls.
- \* Specified performance measured in 85-220V range.
- \* Do not look permanently to the light sources.



NOTES: 1. All dimensions are in millimeter (inches), tolerance is 0.25 unless otherwise noted.  
2. Specifications are subject to change without notice.