

# CB01

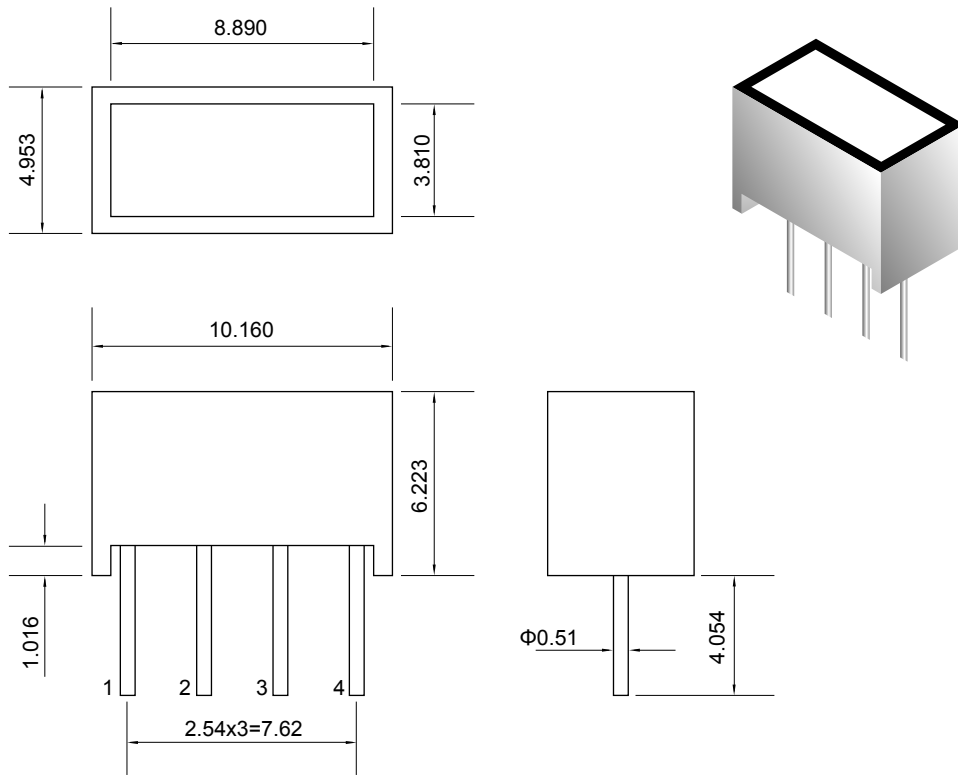

# CB01

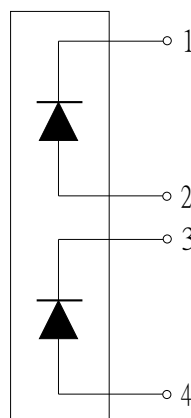

NOTES: 1. All dimensions are in millimeter (inches), tolerance is 0.25 unless otherwise noted.  
2. Specifications are subject to change without notice.